

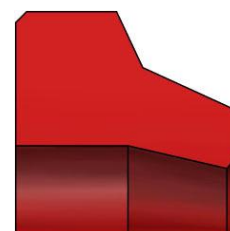

In accordo con la normativa  
DIN 7168 [ Lavorazioni meccaniche ]  
According to Normative DIN 7168  
[ Mechanical Workings ]

**PROFILO / PROFILE RP2**

<i>Materiale</i> <i>Material</i>	<i>Temperatura</i> <i>Temperature</i>	<i>Pressione</i> <i>Pressure</i>	<i>Velocità M/s</i> <i>Speed M/s</i>	<i>Dim max Guarnizione</i> <i>Diam max Seal</i>
NBR01	-30°C + 110°C	-	2	Da 3 mm A 1500 mm
HN100	-40°C + 151°C	-	2	Da 3 mm A 1200 mm
EP100	-45°C + 150°C	-	2	Da 3 mm A 700 mm
FPM01	-20°C + 220°C	-	2	Da 3 mm A 1200 mm
MVG10	-60°C + 220°C	-	2	Da 3 mm A 700 mm
PU100-PU110	-30°C + 110°C	-	0.5	Da 3 mm A 400 mm
CPU01	-30°C + 110°C	-	0.5	Da 3 mm A 2500 mm
CPU03	-30°C + 110°C	-	0.5	Da 3 mm A 2500 mm
CPU04-CPU02	-30°C + 110°C	-	0.5	Da 3 mm A 2500 mm
BPU01	-50°C + 110°C	-	0.5	Da 3 mm A 600 mm
BAU01	-30°C + 110°C	-	1	Da 3 mm A 1500 mm
APU01	-34°C + 133°C	-	0.5	DA 3 mm A 1500 mm

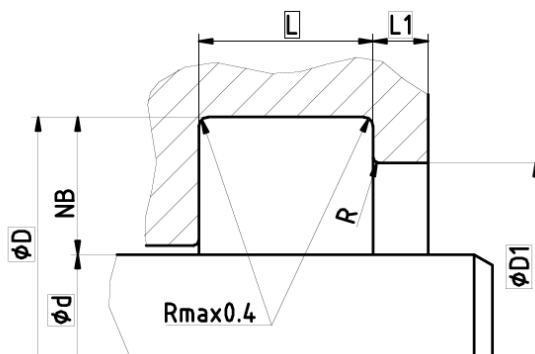

Tolleranza sede Housing tolerances		NB "mm"	R "mm"	Finiture superficiali Surface finishes	Rtmax µm	Ra µm
L < 10mm	+0.2	≤ 5	Max. 0.3	Fondo sede Bottom of groove	≤ 6.3	≤ 1.6
L ≤ 10mm	+0.3	> 5 ≤ 7.5	Max. 0.4	Faccia sede Groove face	≤ 15	≤ 3
D1	H11	> 5 ≤ 10	Max. 0.6			
D	H11	> 10	Max. 0.8			

Dimensioni / Dimensions ISO				
d	NB	L	D1	L1 min
12 ≤ 28	3	4	d+2.5	2
> 28 ≤ 56	4	5	d+3	
> 56 ≤ 110	5	6	d+3	
> 110 ≤ 140	7,5	8,5	d+4	

**Nota:** Per facilitare le operazioni di scelta della guarnizione, con il sistema **ALLSEAL** siamo in grado di assistere il progettista nel corretto dimensionamento della guarnizione, proponendo la soluzione più standard.

**Please Note:** To make the operation easier in choosing the seals with the **ALLSEAL** system, we are able to assist the designer assistant with the correct measurements of the seals, indicating the best solution.